

注意：以下做预设操作方式是在离线模式与联机模式交替使用边听边调试，避免盲调的一种情况。

首先，新建(把相对应产品型号拉出来)或打开之前做过的项目文件，如下图，

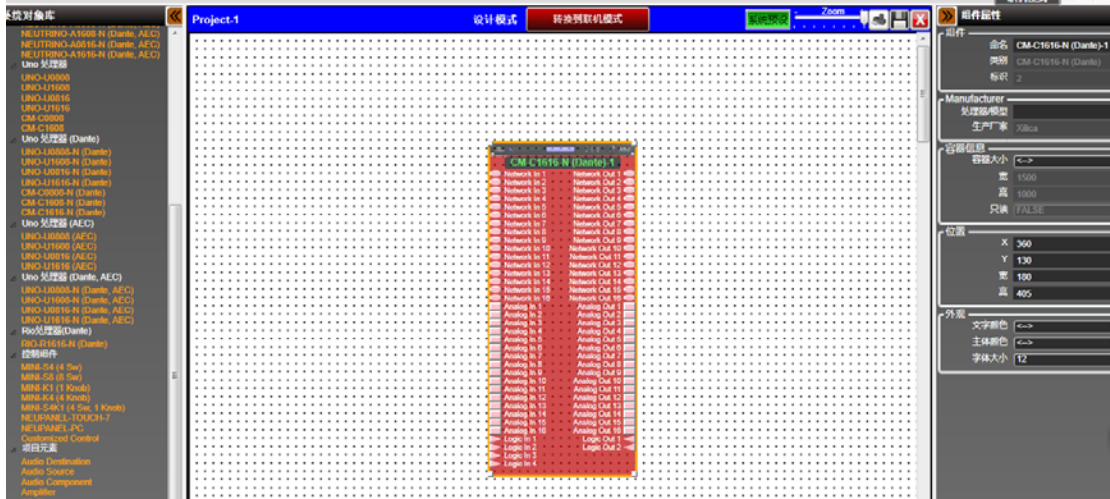

然后右击

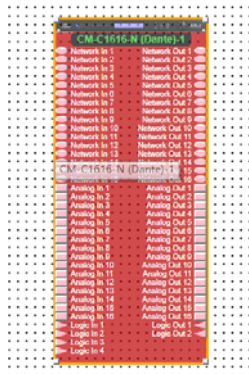

映射处理器后（如之前已经打钩，则不用这一步），点击



进入联机模式后，

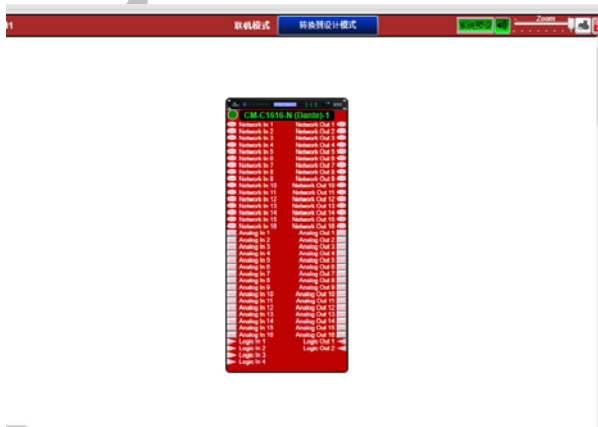

双击

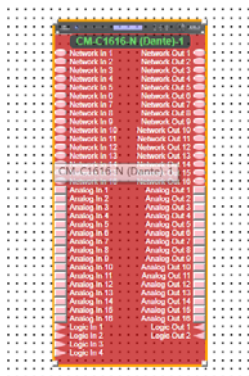

进入下面状态修改里面的参数，

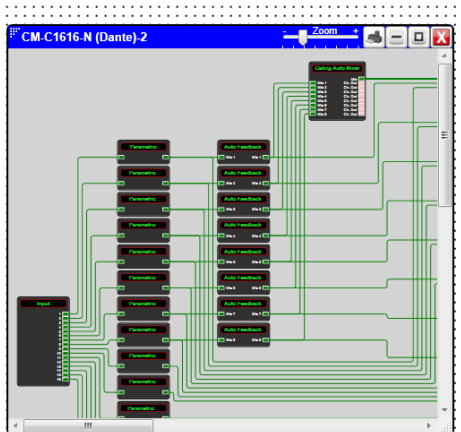

这样就可以边听边调整里面的参数，使效果达到自己满意为止。

修改完后点击

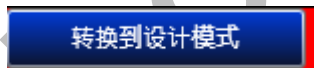

出现下面窗口，点“是”

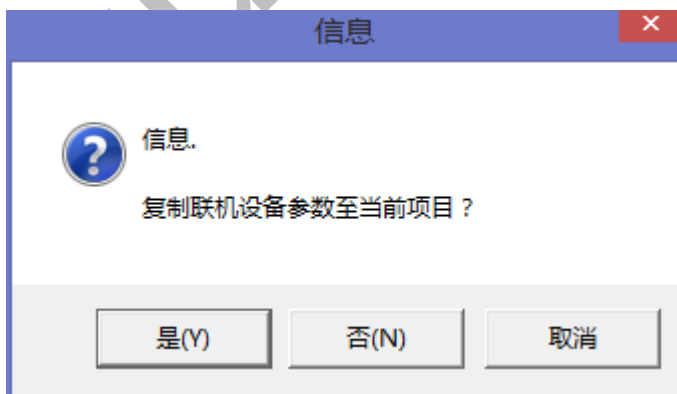

右击它

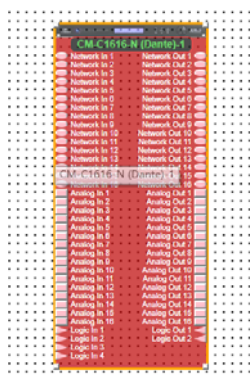

然后选择第三个选项“保存模块数据至预设” 并命名为 xx 模式



这样一种模式修改成功，接着我们现在继续做另外一种模式，

点击



按要求提示全部点“是”

进入到联机模式后，

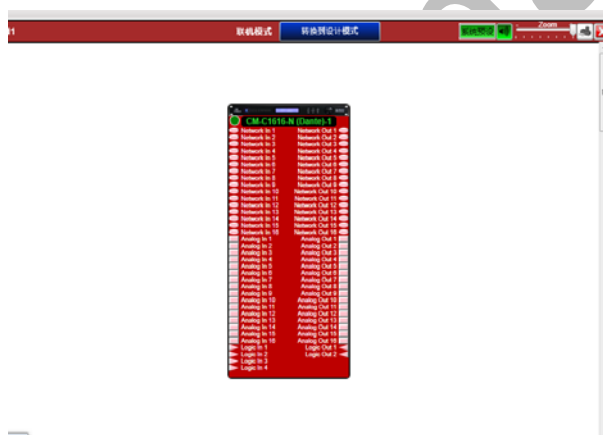

双击

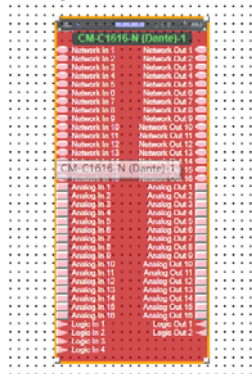

进入下面状态修改里面的参数，

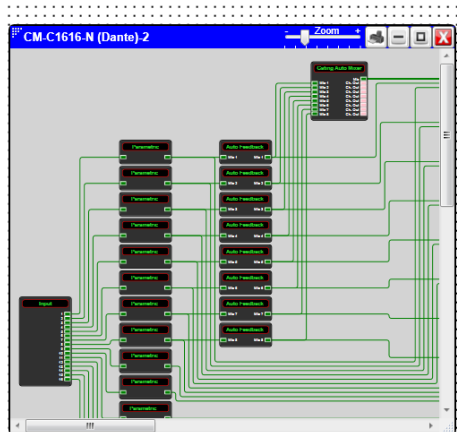

修改完后关闭这些小窗口，回到原来这个状态，

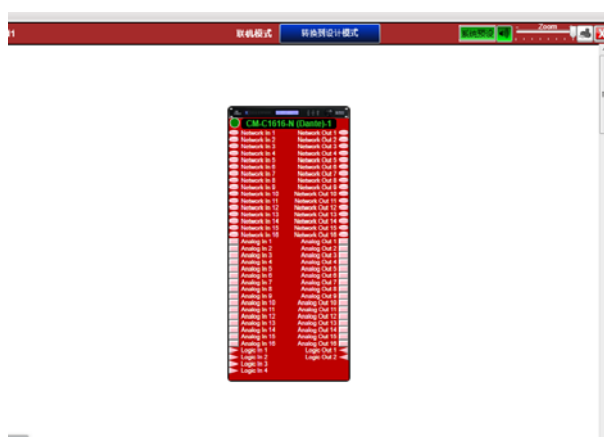

然后点击



出现下面窗口，点“是”

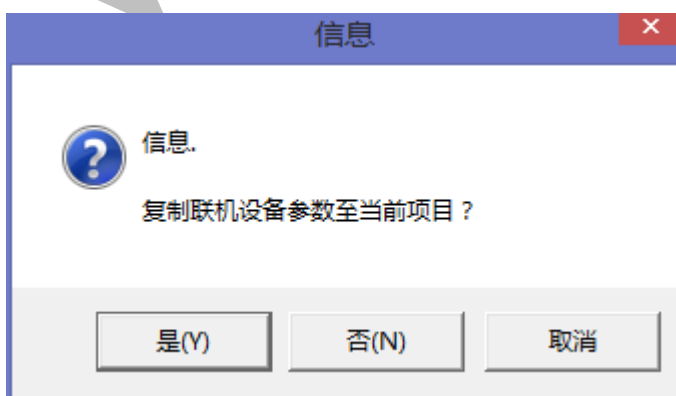

右击它

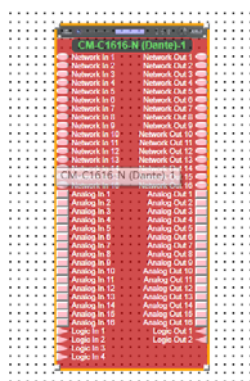

然后选择第三个选项“保存模块数据至预设” 并命名为 xx 模式



这样另一种模式修改成功,

点击



全部按 yes,保存完后, 等数据上传完以后, 就可以在右上角



“系统预设”里调用。